

A	B	C	D	E	F
8'	11'	22'9"	21'5"	6'7"	9'
10'	13'	22'9"	21'5"	8'7"	11'
12'	15'	22'9"	21'5"	10'7"	13'
14'	17'	22'9"	21'5"	12'7"	15'
16'	19'	22'9"	21'5"	14'7"	17'
18'	21'	22'9"	21'5"	16'7"	19'

24'

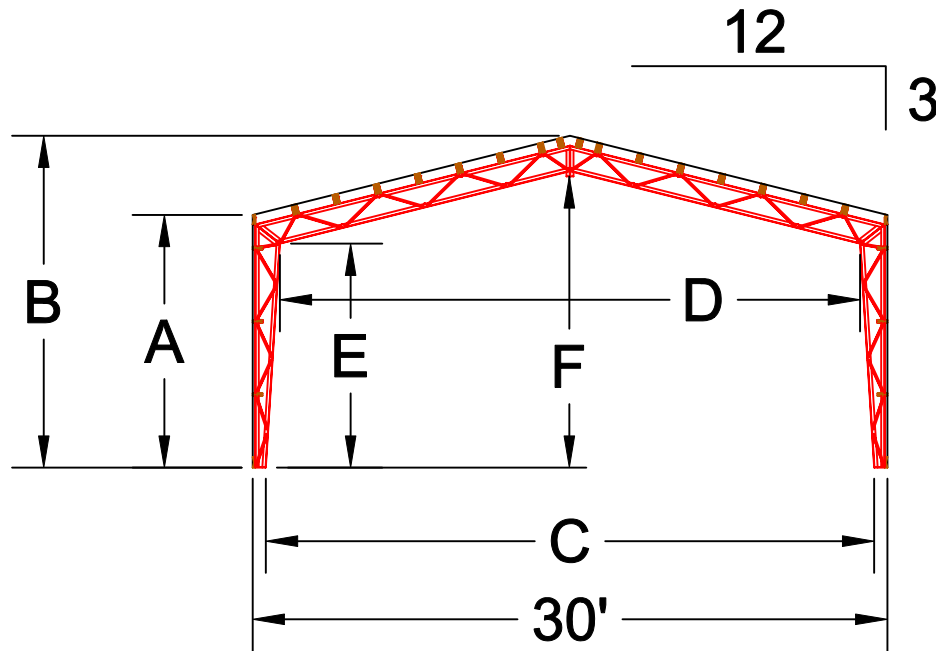

A	B	C	D	E	F
8'	11'9"	28'9"	27'5"	6'7"	9'9"
10'	13'9"	28'9"	27'5"	8'7"	11'9"
12'	15'9"	28'9"	27'5"	10'7"	13'9"
14'	17'9"	28'9"	27'5"	12'7"	15'9"
16'	19'9"	28'9"	27'5"	14'7"	17'9"
18'	21'9"	28'9"	27'5"	16'7"	19'9"

30'

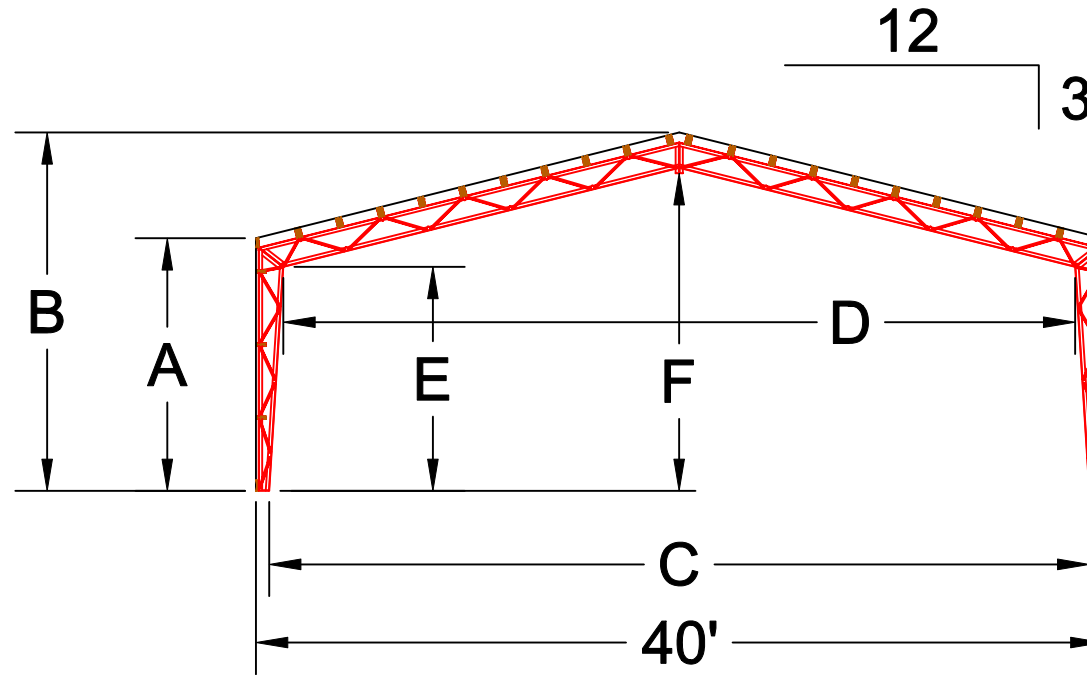

A	B	C	D	E	F
10'	15'	38'9"	37'5"	8'7"	13'
12'	17'	38'9"	37'5"	10'7"	15'
14'	19'	38'9"	37'5"	12'7"	17'
16'	21'	38'9"	37'5"	14'7"	19'
18'	23'	38'9"	37'5"	16'7"	21'
20'	25'	38'9"	37'5"	18'7"	23'

40'

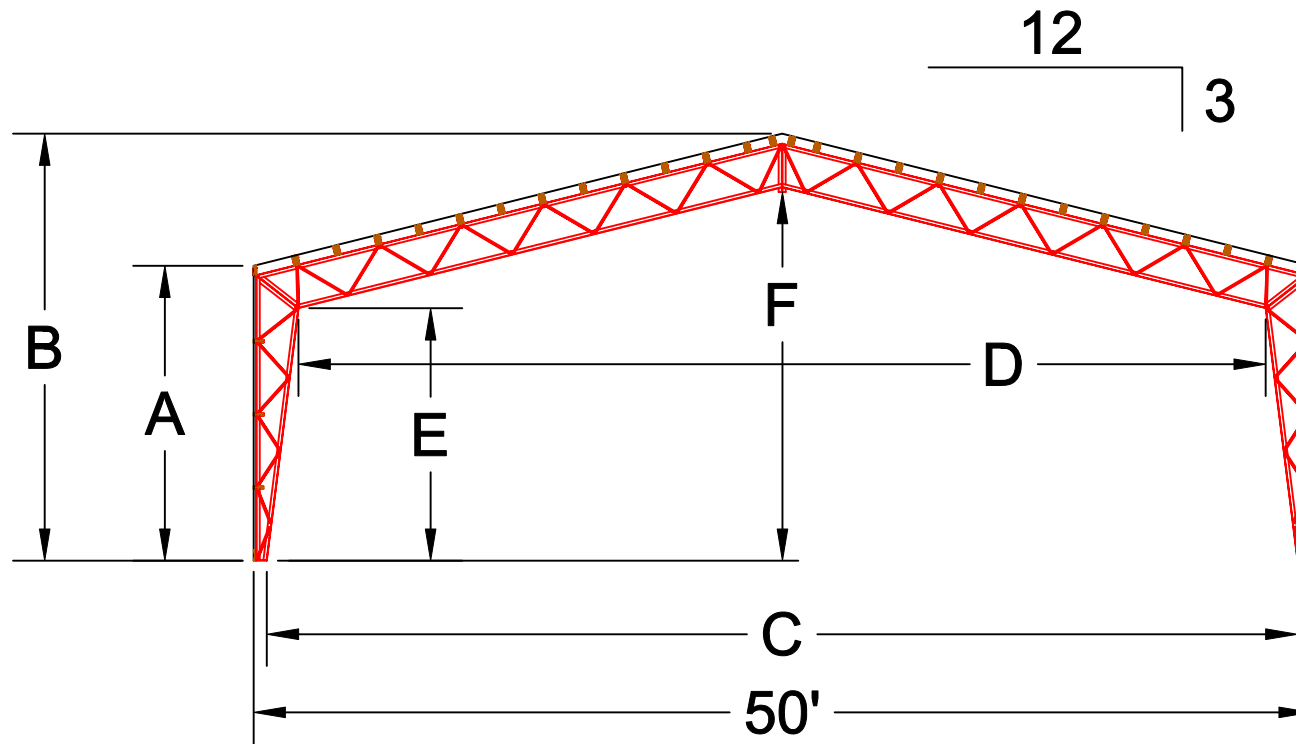

A	B	C	D	E	F
10'	16'3"	48'9"	46'9"	8'	13'5"
12'	18'3"	48'9"	46'9"	10'	15'5"
14'	20'3"	48'9"	46'9"	12'	17'5"
16'	22'3"	48'9"	46'9"	14'	19'5"
18'	24'3"	48'9"	46'9"	16'	21'5"
20'	26'3"	48'9"	46'9"	18'	23'5"

50'

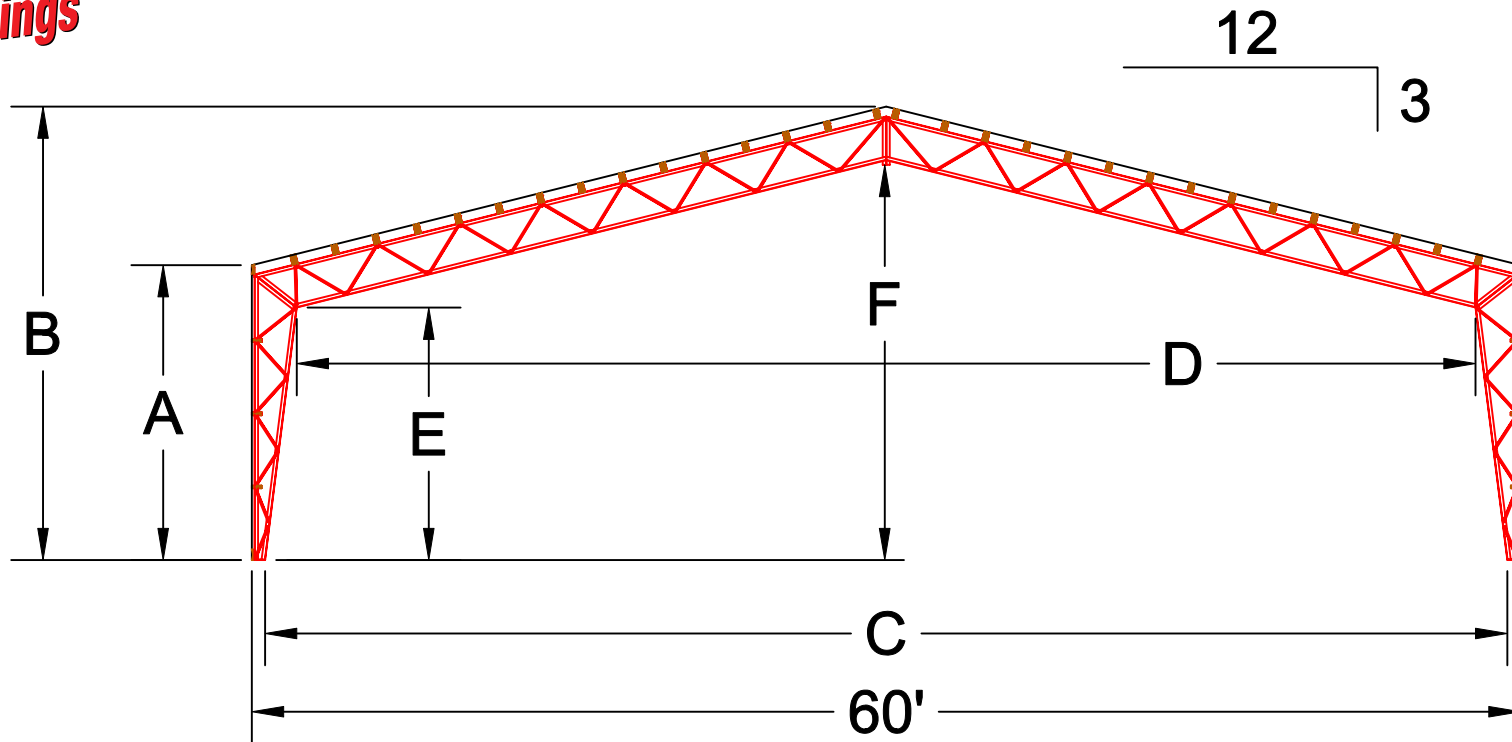

A	B	C	D	E	F
10'	17'6"	58'9"	56'9"	8'	14'8"
12'	19'6"	58'9"	56'9"	10'	16'8"
14'	21'6"	58'9"	56'9"	12'	18'8"
16'	23'6"	58'9"	56'9"	14'	20'8"
18'	25'6"	58'9"	56'9"	16'	22'8"
20'	27'6"	58'9"	56'9"	18'	24'8"

60'

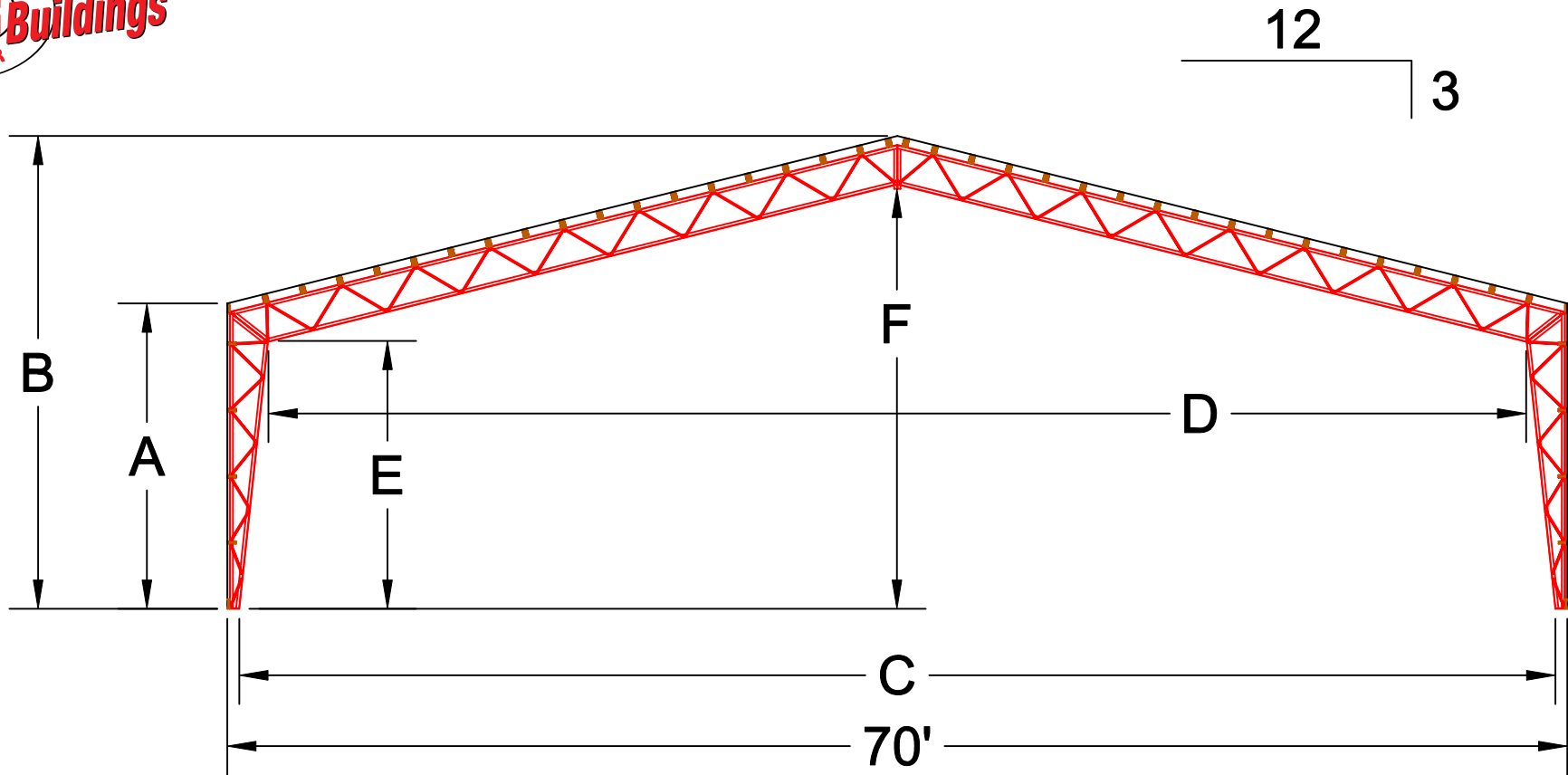

A	B	C	D	E	F
10'	18'9"	68'9"	66'9"	8'	15'11"
12'	20'9"	68'9"	66'9"	10'	17'11"
14'	22'9"	68'9"	66'9"	12'	19'11"
16'	24'9"	68'9"	66'9"	14'	21'11"
18'	26'9"	68'9"	66'9"	16'	23'11"
20'	28'9"	68'9"	66'9"	18'	25'11"

70'

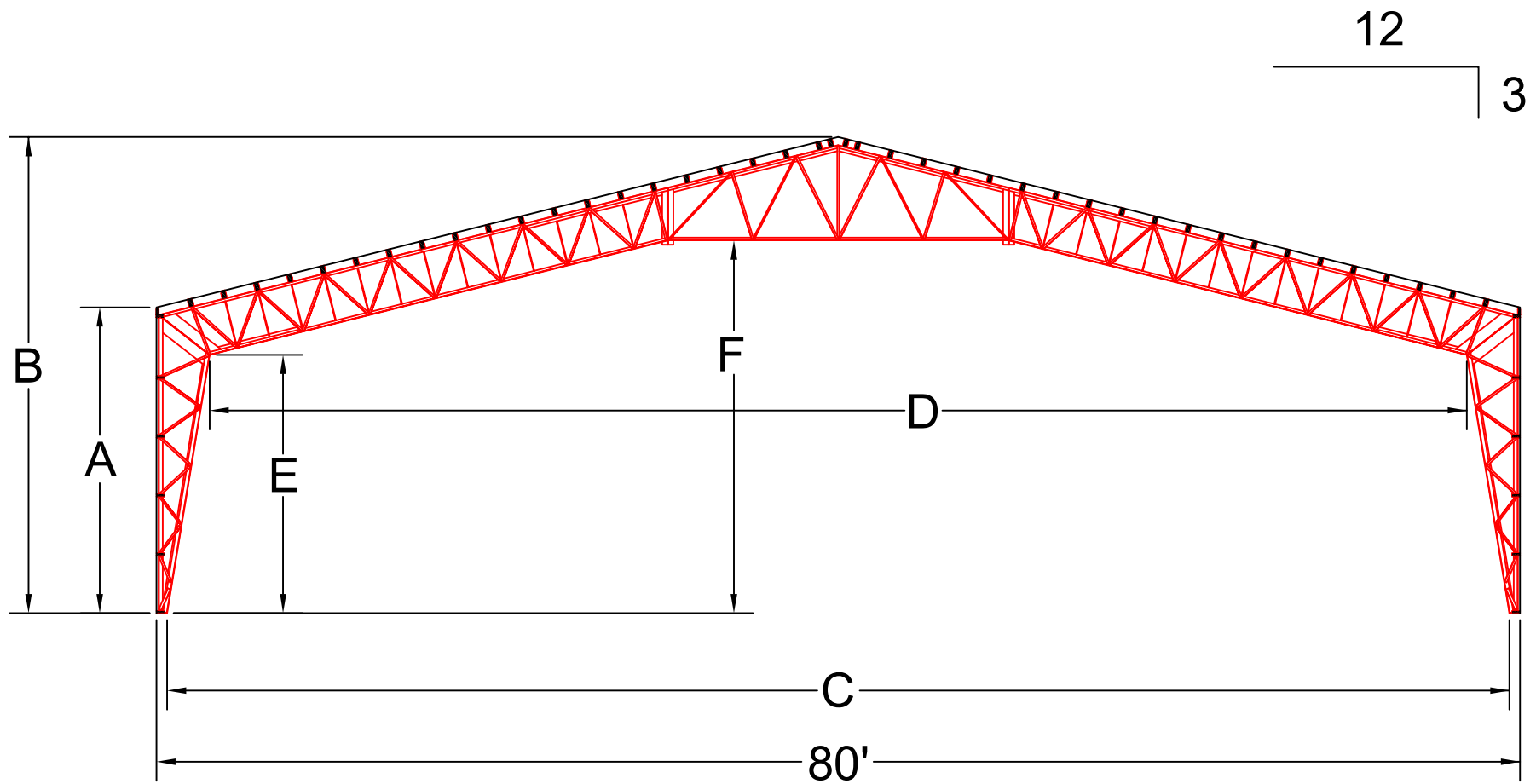

A	B	C	D	E	F
12'	22'0"	78'9"	73'9"	9'2"	15'11"
14'	24'0"	78'9"	73'9"	11'2"	17'11"
16'	26'0"	78'9"	73'9"	13'2"	19'11"
18'	28'0"	78'9"	73'9"	15'2"	21'11"
20'	30'0"	78'9"	73'9"	17'2"	23'11"

80'

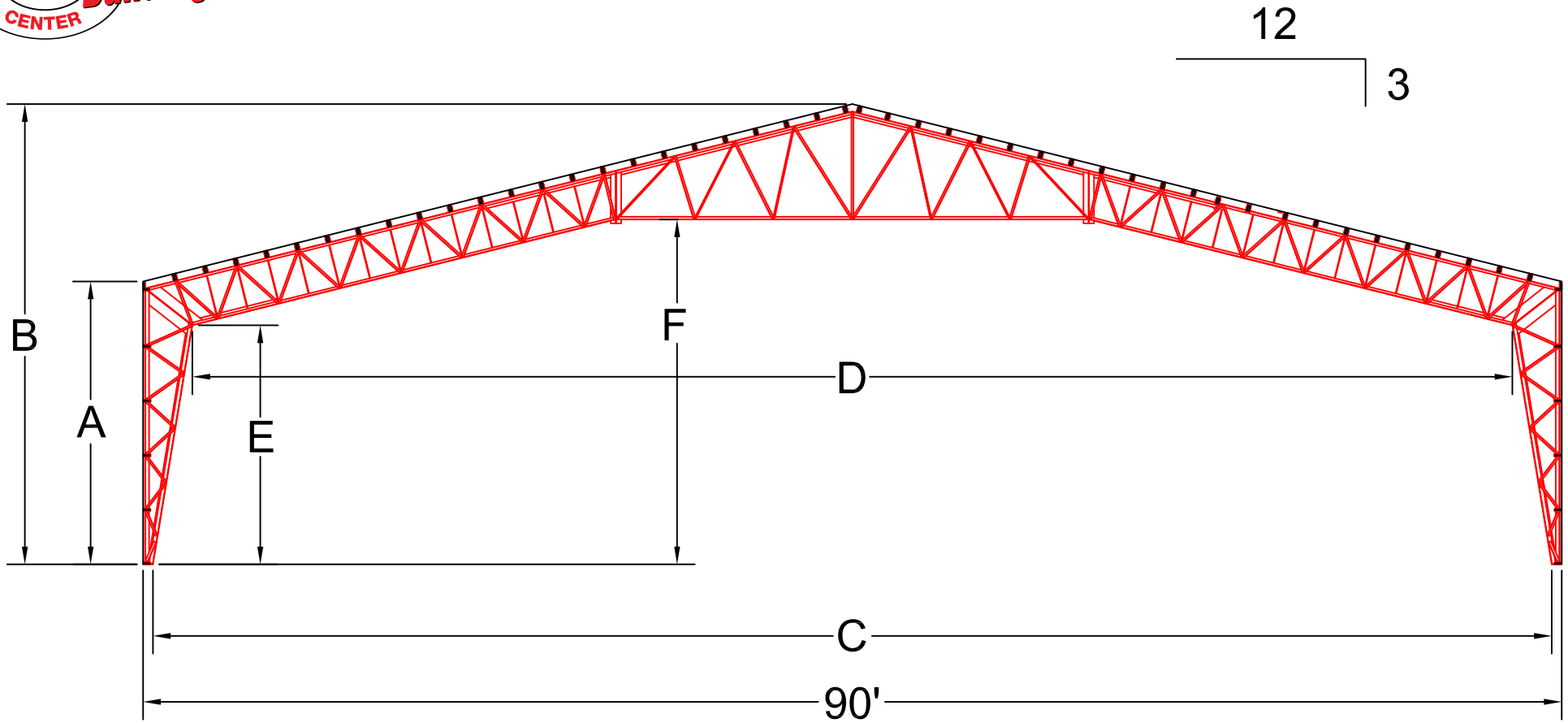

A	B	C	D	E	F
12'	23'3"	88'9"	83'9"	9'2"	15'10"
14'	25'3"	88'9"	83'9"	11'2"	17'10"
16'	27'3"	88'9"	83'9"	13'2"	19'10"
18'	29'3"	88'9"	83'9"	15'2"	21'10"
20'	31'3"	88'9"	83'9"	17'2"	23'10"

90'

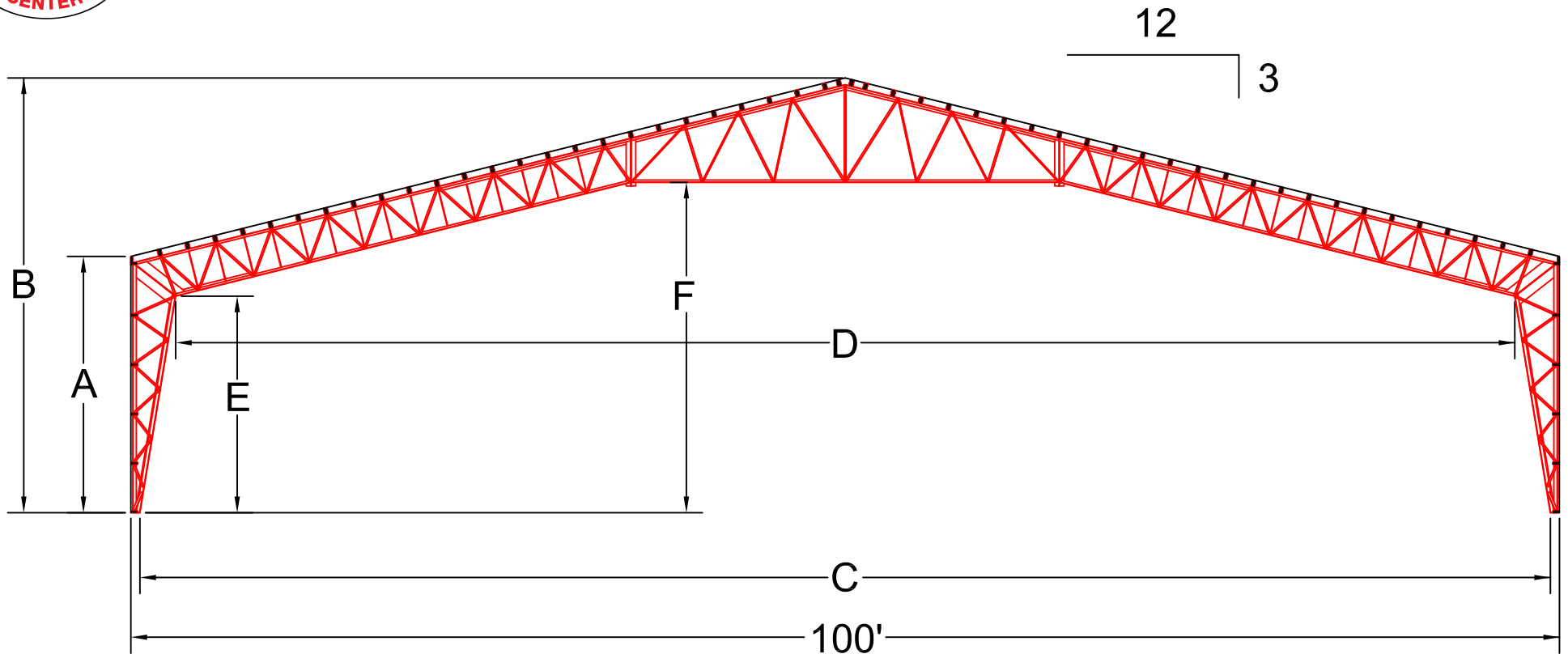

A	B	C	D	E	F
12'	24'6"	98'9"	93'9"	9'2"	17'1"
14'	26'6"	98'9"	93'9"	11'2"	19'1"
16'	28'6"	98'9"	93'9"	13'2"	21'1"
18'	30'6"	98'9"	93'9"	15'2"	23'1"
20'	32'6"	98'9"	93'9"	17'2"	25'1"

100'